

# GTZ-1500 SERIES

HIGH PRODUCTIVITY MULTI-AXIS TURNING CENTERS

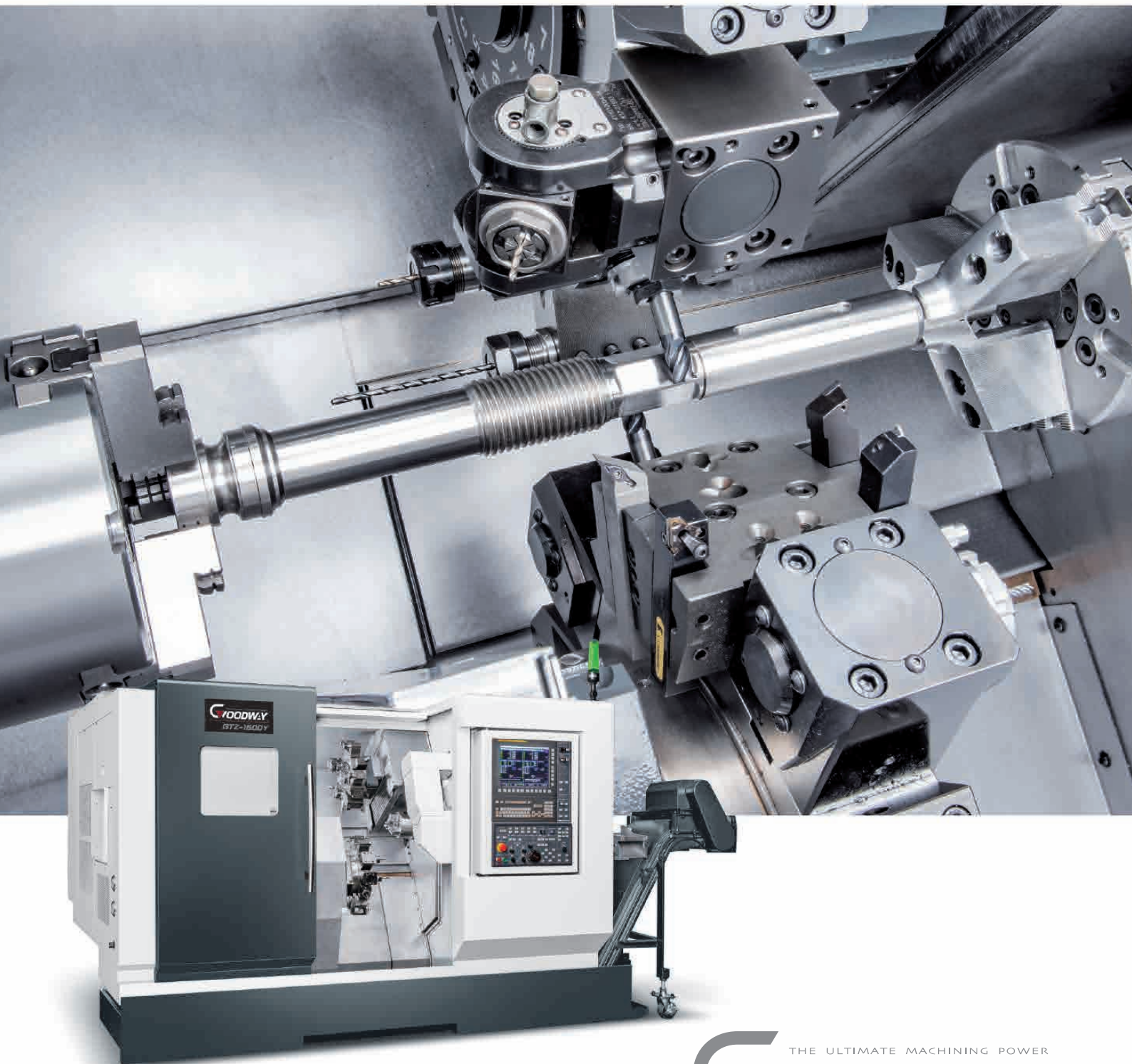

THE ULTIMATE MACHINING POWER  
**WOODWAY**

# GOODWAY'S FULL RANGE OF MULTI-AXIS TURNING AND MILLING MACHINES

Our strong performance and comprehensive specifications are sure to complete every complicated processing needs. Whether it's the pursuit for efficient and reliable mass production or professional users who needs to process a complex workpiece. GOODWAY's full range of multi-axis turning and milling machines are going to be your best solution.

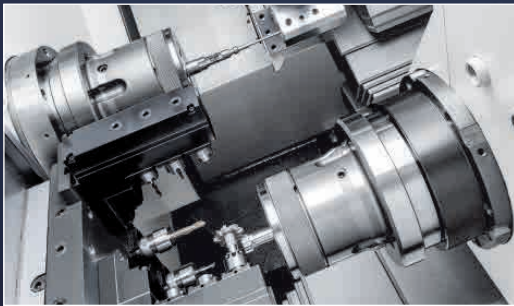
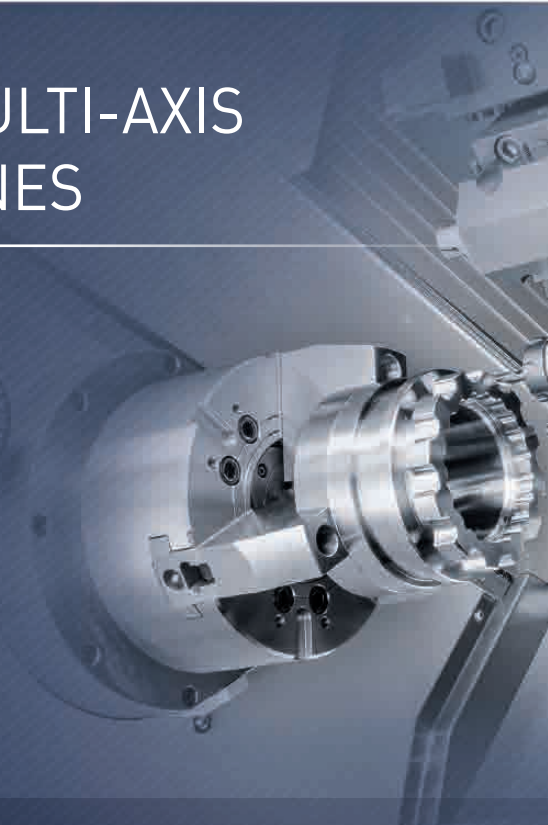

Turret / Gang Tooling System — GTW SERIES

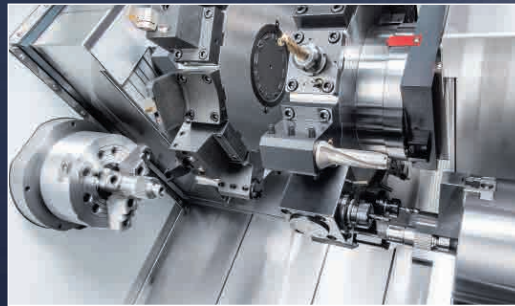

Opposite Twin Turrets — GTS SERIES



Parallel Twin Turrets



## GTW SERIES

Turret / Gang Tooling System

Chuck size : 6" / CL42 / CL52  
 Bar capacity : Ø51 mm  
 Turret station : 12T  
 Gang tooling stations : 8T  
 Twin Y axes control\*2

## GTS SERIES

Opposite Twin Turrets

Chuck size : 6" / 8" / 10"  
 Bar capacity : Ø42 / Ø51 / Ø65 mm  
 Turret station : 12T\*1  
 Twin Y axes control\*2

## GTH SERIES

Parallel Twin Turrets

Chuck size : 10"  
 Max. turning diameter : Ø300 mm  
 Turret station : 12T / 16T\*1  
 Standard automatic load/unload system

\*1 Twin turrets have identical turret capacities.

\*2 The specification may be an optional function, please contact GOODWAY for more information.

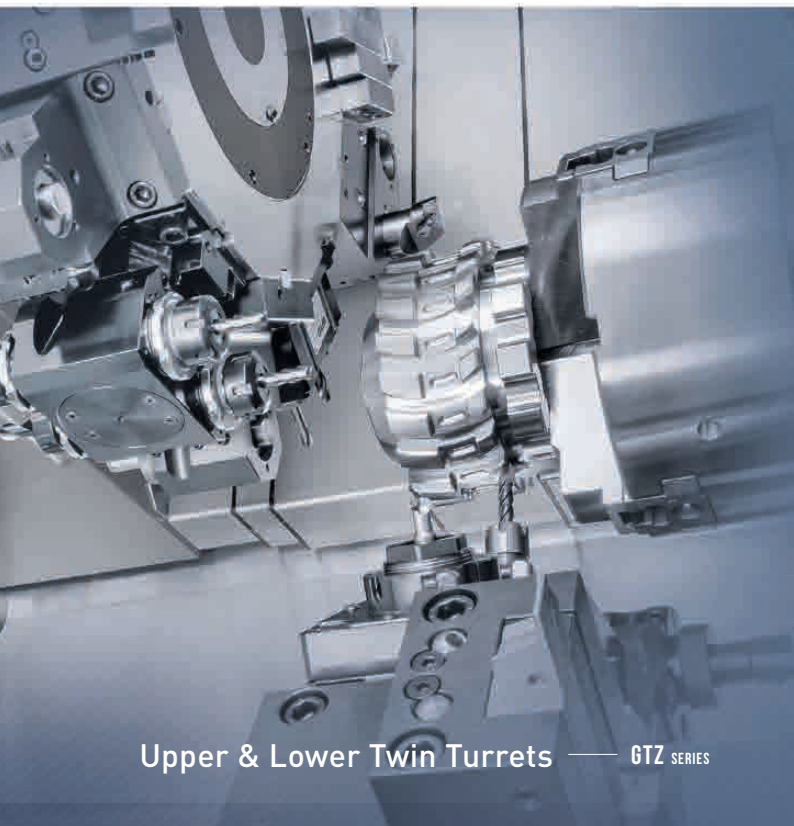

Upper & Lower Twin Turrets — GTZ SERIES



**Aerospace Engine blower disk**

- Processing time : 4 hr 52 min
- Material : SUS304
- Size : Ø150mm / 80mm ( H )



**Automobile industry Scroll**

- Processing time : 38 min 10 sec
- Material : 7079-T6
- Size : Ø82mm / 35mm ( L )



**Bicycle industry Hub**

- Processing time : 6 min 30 sec
- Material : AL6061
- Size : Ø66mm / 40mm ( L )



— GTH SERIES B-axis Milling Spindle — GMT SERIES



**Medical industry  
Pneumothorax puncture device**

- Processing time : 4 min 25 sec
- Material : SUS316
- Size : Ø20mm / 75mm ( L )

( All series are available with twin spindles. )



**GTZ SERIES**

Upper & Lower Twin Turrets

- Chuck size : 6" / 8" ( Big-Bore )
- Bar capacity : Ø45 / Ø51 / Ø65 mm
- Turret station : 12T / 16T / 24T<sup>\*1</sup>
- Twin Y axes control<sup>\*2</sup> (GTZ-1500)



**GMT-2000 SERIES**

Milling Spindle / Lower Turrets

- Chuck size : 8" / 10" / 12"
- Bar Capacity : Ø65 / Ø80 / Ø102 mm
- Max. B-axis travel : + 210° ~ -30°
- Magazine capacity : 40T / 80T / 120T
- Y-axis control ( Milling spindle )



**GMT-4000 SERIES**

Milling Spindle

- Chuck size : 15" / 24"
- Bar capacity : Ø90 mm
- Max. B-axis travel : + 210° ~ -30°
- Magazine capacity : 40T / 80T / 120T
- Y-axis control ( Milling spindle )

# UPPER & LOWER TWIN TURRETS / TWIN Y AXES

When facing a dilemma of maintaining a highly efficient production while processing extremely complicated machining parts, GOODWAY GTZ-1500 series is your best solution. This model is based on an ultra-solid 60° true slant bed, with the advanced structural design of twin spindles, twin Y-axis and twin live tooling turrets. Any complex parts can be completed by a GTZ-1500 in a single setup. In addition, this series provides three bar diameters of Ø45 / Ø51 / Ø65 mm, satisfying your processing needs for various workpiece sizes.

## Compact Floor Space



The processing capacity of GTZ-1500 is equivalent to two turning and milling machines, thereby saving 40% floor space.

## Twin Y Axes Control Function

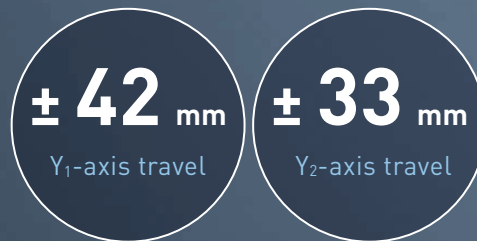

The Y-axis control function allows eccentric processing needs such as milling and drilling, completing complicated processing tasks with ease.

## Abundant Turret Capacity

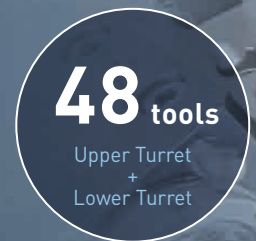

A single turret can be equipped with up to 12 driven tools or 24 standard tools. ( Half indexing )

## General machining process

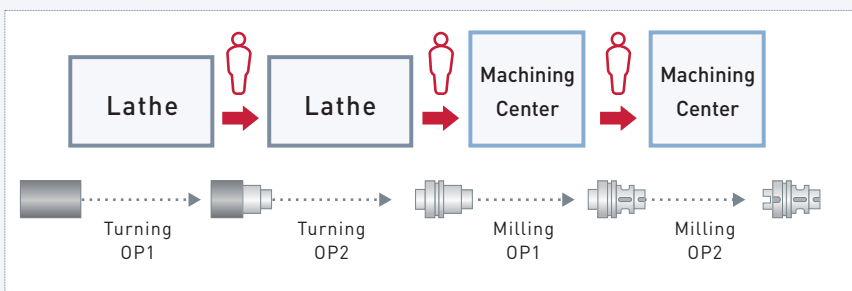

## GTZ-1500

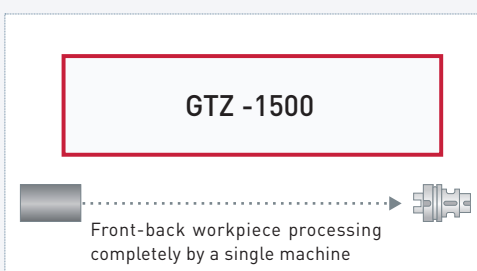

**Significantly improve productivity**

## Advantages of GTZ-1500

( compared to conventional processing procedures )

- Avoid displacement from repeatedly clamping / unclamping work pieces.
- Save time for loading / unloading.
- Reduce labor cost.
- Minimize floor space taken.
- Lower cost of equipment investment.
- Shorten delivery time.



[ GTZ-1500Y model shown with optional parts catcher. ]

# FLEXIBLE MACHINING MODES

Both upper and lower turrets can agilely support the two spindles; in addition, through clamping the both sides of work piece on the twin spindles, synchronous high precision balanced turning can be performed, which allows for more flexibility in processing arrangement. Its capability of up to 8 axes control, along with  $X_1 / Z_1 / C_1 / Y_4$  axes synchronous processing, can easily accomplish all previously difficult machining jobs.

Maximum  
**8** axes control

Synchronic  
**4** axes machining

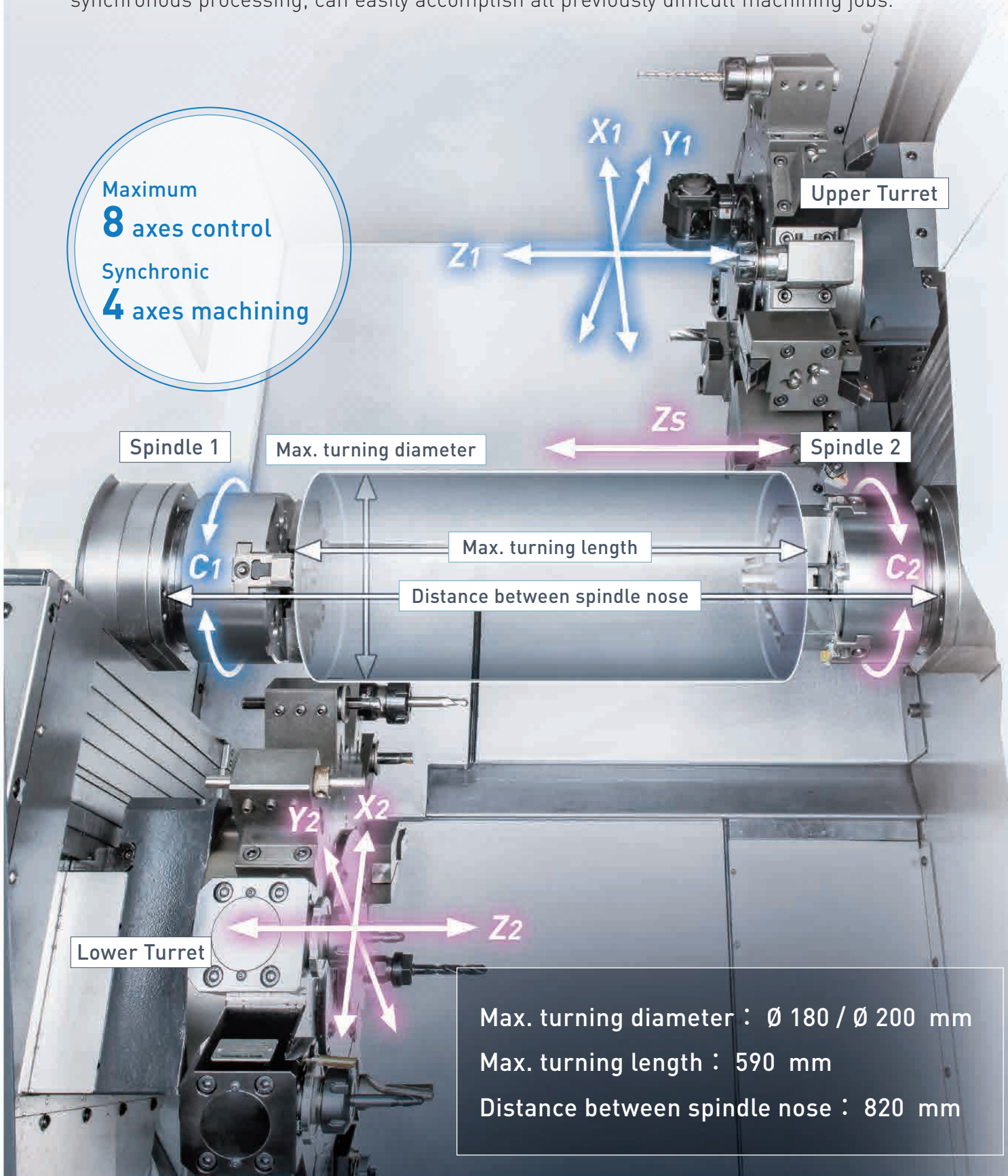

Upper turret works on spindle 1  
Lower turret works on spindle 2

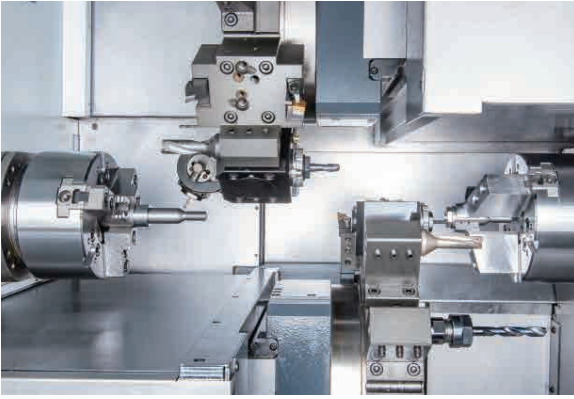

Upper turret works on spindle 2  
Lower turret works on spindle 1

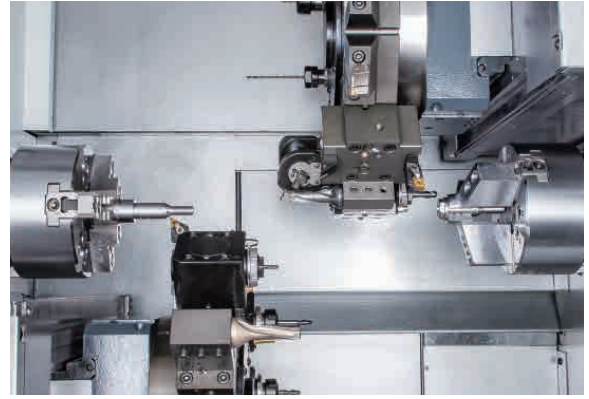

Synchronic balanced cutting on the work piece from upper and lower twin turrets

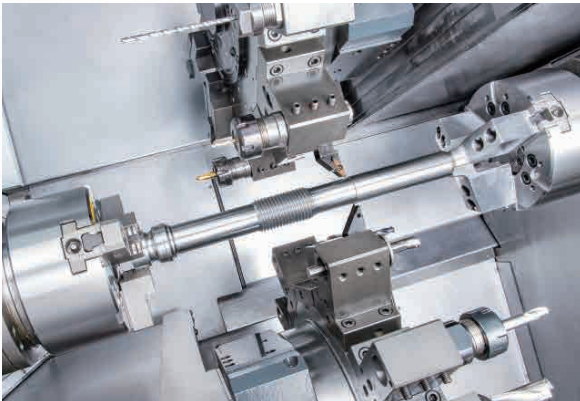

Twin spindles simultaneous part catching



Upper & lower twin turrets synchronously work on spindle 1



Upper & lower twin turrets synchronously work on spindle 2

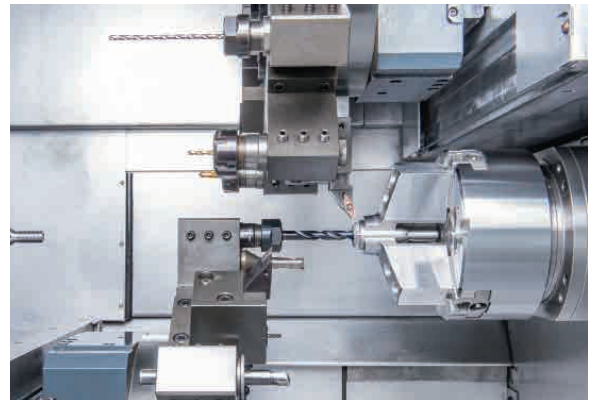

Y-axis simultaneous processing

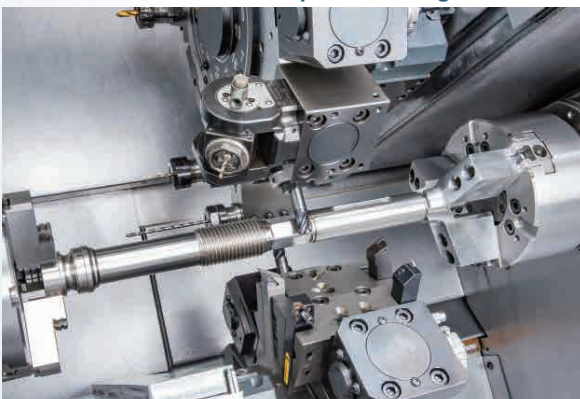

Deep-hole drilling

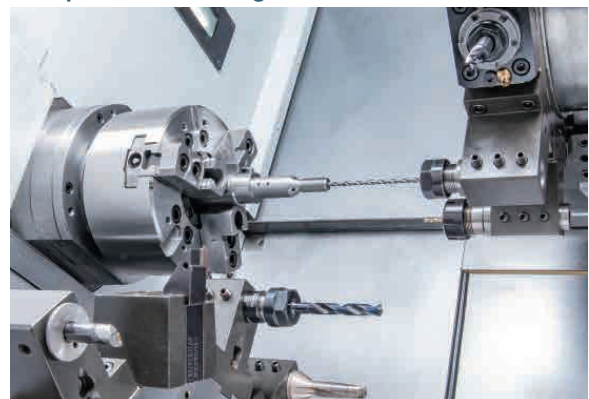

# ADVANCED MECHANISM DESIGN

The main castings of the GTZ-1500 series are all finished with the final processing procedures in the GOODWAY factory; the core components such as the turret and spindle are assembled and verified in GOODWAY's precision assembly plant. The self-manufacturing ability of key components allows us to strictly control the quality of our products, thereby ensuring that the performance of the machine can be maximized.

## Finite Element Methods ( FEM )

All structural components are analyzed with Finite Element Methods ( FEM ), assuring highest rigidity of ensemble with advantages in optimized design as well as light-weight structure.

## High Rigidity Casting Structure

Main structural units such as machine base, headstock and saddle are die-casted from high damping Meehanite of low deformation in one piece, along with specialized reinforced rib design. All main units are characterized by high rigidity and damping capacity, which can effectively reduce possible structural deformation.

## One-piece Casting 60° True Slant Bed

- High rigidity which provides extremely stable base for spindle and turret.
- Chips can slide down to the chip conveyor more easily due to their own weight.
- Shorten the distance between operator and working area.
- Less floorspace capacity.

## Individual Z<sub>1</sub>, Z<sub>2</sub>, Z<sub>s</sub> Axis Guideway Design

The upper and lower turrets and the sub-spindle adopt an independent three-guideway design, greatly reducing restrictions between units, ensuring maximum mobility between each axis. Therefore, the GTZ-1500 series is able to meet your various processing needs with more flexible procedures, significantly improving machining efficiency.





## High Precision Linear Guide Ways

High precision linear guide ways on X / Z axes to ensure ultimate rigidity and speed advantage. Z-axis (  $Z_1$ ,  $Z_2$ ,  $Z_s$  ) has a fastest feed rate that goes up to 40 m/min.

$Z_1$ ,  $Z_2$ , and  $Z_s$  axes guideway are designed with heavy-duty six-slide blocks, which provides the best rigid support for the upper and lower turrets and the sub-spindle.

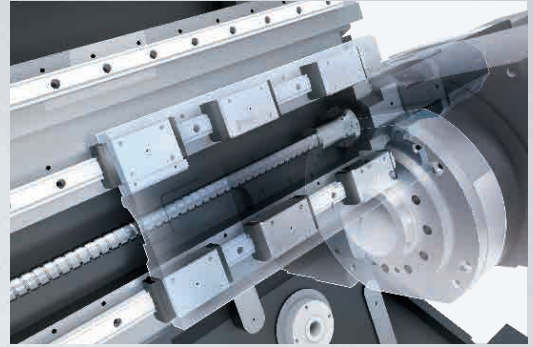

## High Accuracy Ball Screw

C3 class ball screws, heat-treated and precision grinded, ensure the highest precision and durability possible. In addition, each axis has a pre-tensioning design, which can minimize the displacement and greatly improve processing accuracy.

The Z-axis ball screw motor housing and the base are formed integrally, which allows the cutting stress to be evenly distributed on the casting body, effectively improving the overall rigidity of the axial system and avoiding screw rotation and deformation.

## Sufficient Y-axis Travel

The oblique design of the Y-axis structure allows this series to achieve a large Y-axis stroke (  $Y_1 = \pm 42$  mm,  $Y_2 = \pm 33$  mm ) with a very small machine size. Y-axis movement through X and  $X_s$  compound method to achieve.

The Y-axis guideway adopts a box way design. The box way is heat-treated and precisely grounded to meet the needs of heavy cutting and other processing applications.

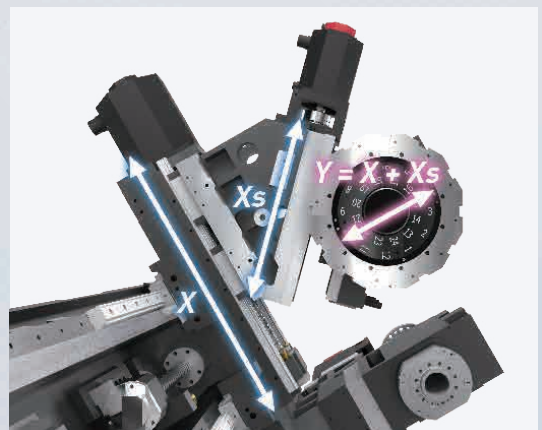

# OPTIMIZED TWIN SPINDLES SYSTEM

The twin spindles are designed with the same specifications and controlled by two systems, which allows them to work independently at the same time to shorten the processing time. It can also perform high-precision cutting by clamping both ends of a long bar.

- P4 grade ( Class 7 ) super-high precision bearings are directly assembled for maximum level of support and precision. Bearing configuration is designed for super heavy-duty cutting (with ultra-smooth performance and long term durability with a higher level of accuracy.
- The configuration of double row roller bearing and angular contact ball bearing can significantly reduce vibration of spindle radial direction and axial thermal deformation, securing the high rigidity of spindles.

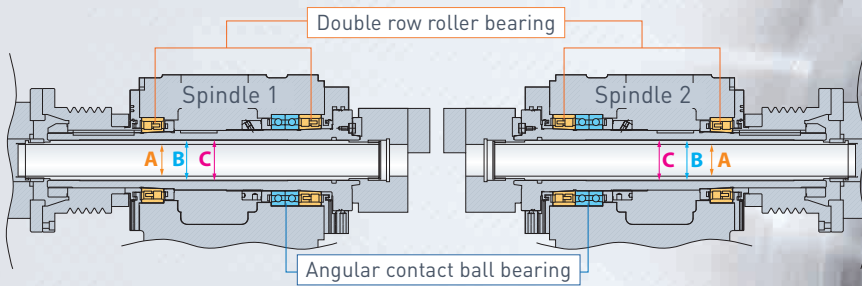

GTZ-1500				
A	Hole through draw tube	Ø 46 mm	Ø 52 mm	Ø 66 mm
B	Draw tube OD.	Ø 55 mm	Ø 62 mm	Ø 77 mm
C	Hole through spindle	Ø 56 mm	Ø 63 mm	Ø 78 mm



## Spindle Output

STD.

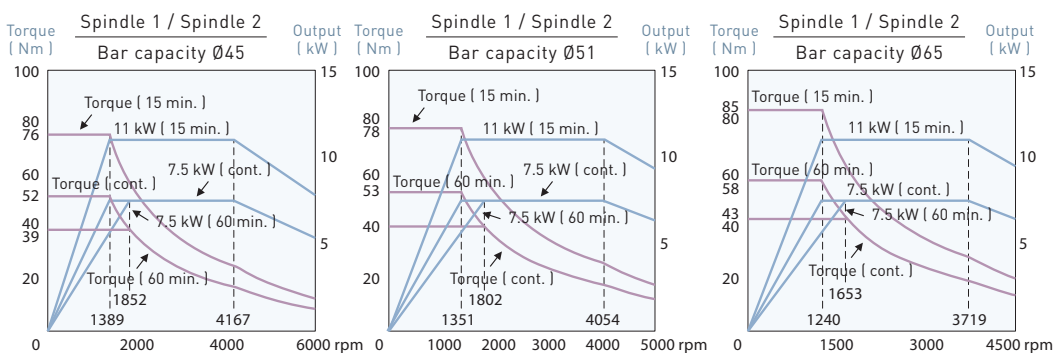

## Spindle Acc. / Dec. Time

Model	GTZ-1500	
Spindle	Spindle 1	Spindle 2
Acceleration	( 0 → 5,000 rpm )	
	3.09	3.07
Deceleration	( 5,000 → 0 rpm )	
	2.9	2.9

Unit : sec.

OPT.

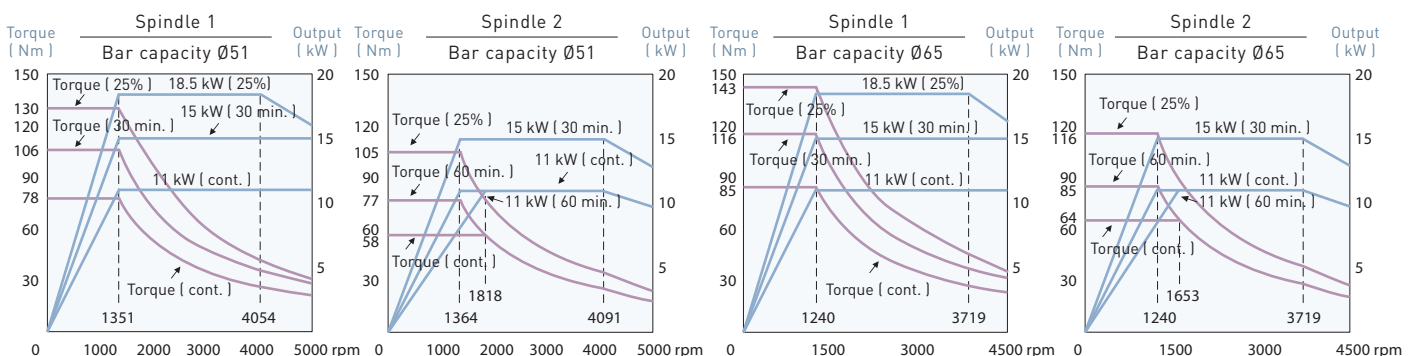

# GOODWAY'S LIVE TOOLING TURRET

A maximum of up to

**48** tools

( half index )

can be installed

Upper Turret 24 tools

+

Lower Turret 24 tools

- All series live tooling turret are designed and manufactured by GOODWAY.
- 12 or 24 stations turret are available to meet any needs.
- High speed servo indexing turret technology, achieving 0.2 second indexing for adjacent stations.
- Ultra-high precise curvic couplings accurately position the turret disk.
- GOODWAY provides a full range of power tool holders for selection to correspond to any complex machining tasks.

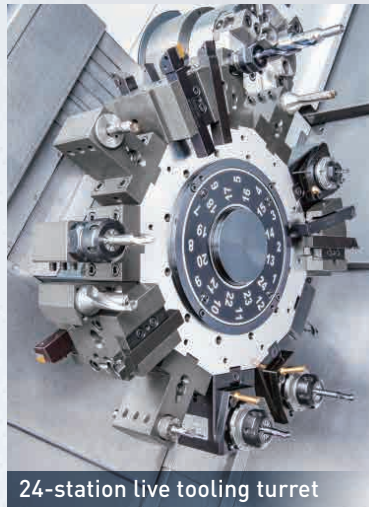

24-station live tooling turret

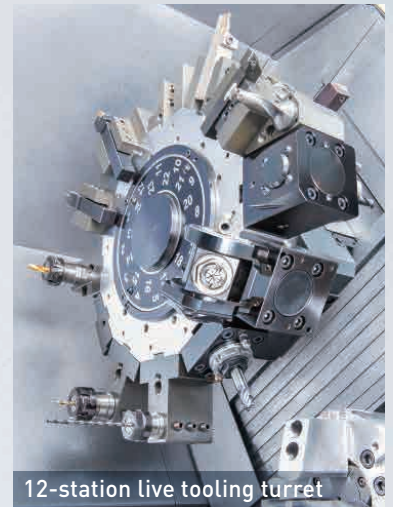

12-station live tooling turret

Live Tooling Turret	12-station	24-station
Stations	12	24
Live tooling stations	12	12
O.D. tool shank size	□ 20 mm	□ 16 mm
I.D. tool shank size	∅ 25 mm	∅ 25 mm
Live tooling shank size	ER20	ER20

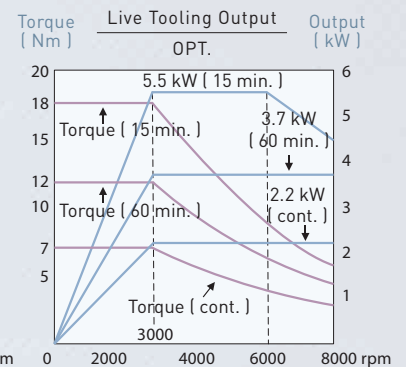
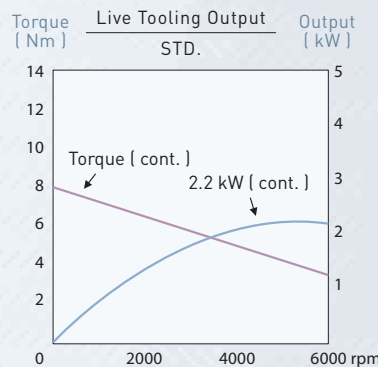

## High-horsepower Milling Motor

The power tool adopts the advanced technology of AC servo motor drive mode, enabling massive power output through its high torque. Customers can also select a 5.5 kW high-horsepower spindle motor drive for more complex processing tasks.

## Equipment of Automatic Oil Mist Lubrication

The oil mist lubrication system will automatically spray in time and ration during the milling process, without the need for manual replenishment of grease. It can provide efficient cooling to the transmission mechanical parts such as bevel gears, meeting the processing needs of long-term high-speed milling.

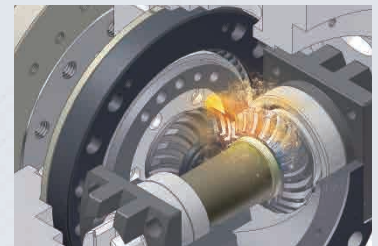

## Three-piece Curvic Coupling

This series adopts ultra-high precision 3-piece curvic coupling to position the turret disk precisely, ensuring sufficient turret rigidity in any cutting situation. Moreover, the turret index can be completed without disk lifting.

The curvic coupling has a large tooth engaging surface which can be automatically centered, so as to ensure excellent tool change accuracy.

( The tool indexing repeatability of GTZ-1500 series is ensured at  $\pm 0.003$  mm )

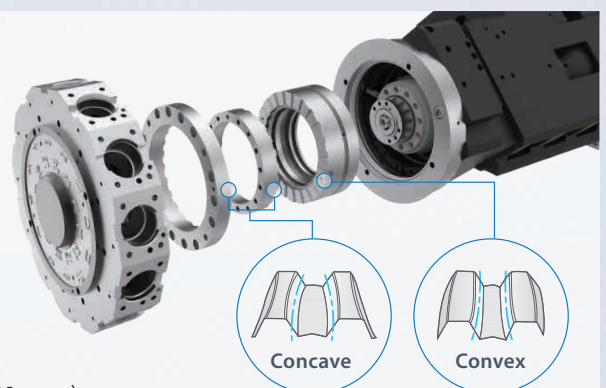

# ULTIMATE C-AXIS SPINDLE

In our highly efficient C<sub>s</sub>-axis design, spindle mode can be directly switched to C-axis servo mode. Fast indexing speed, along with a minimum spindle indexing angle of 0.001°, facilitates optimal performance.

The optional C-axis control function can greatly reduce the time required for twin-spindle synchronization, such as in twin-spindle synchronic part catching. In average, the efficiency of C-axis synchronization is 5 times more than that of twin-spindle synchronization mode.

Working with the live tooling turret, the C<sub>s</sub>-axis and disk brake system enables the machine to perform multiple tasks, such as drilling, tapping, and milling operations, including cylindrical and polar coordinate interpolations, resembling a 4<sup>th</sup>-axis rotary table on a machining center.

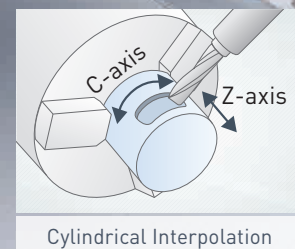
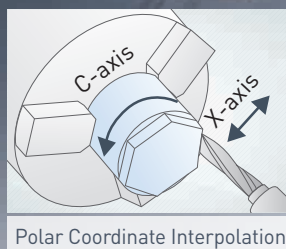
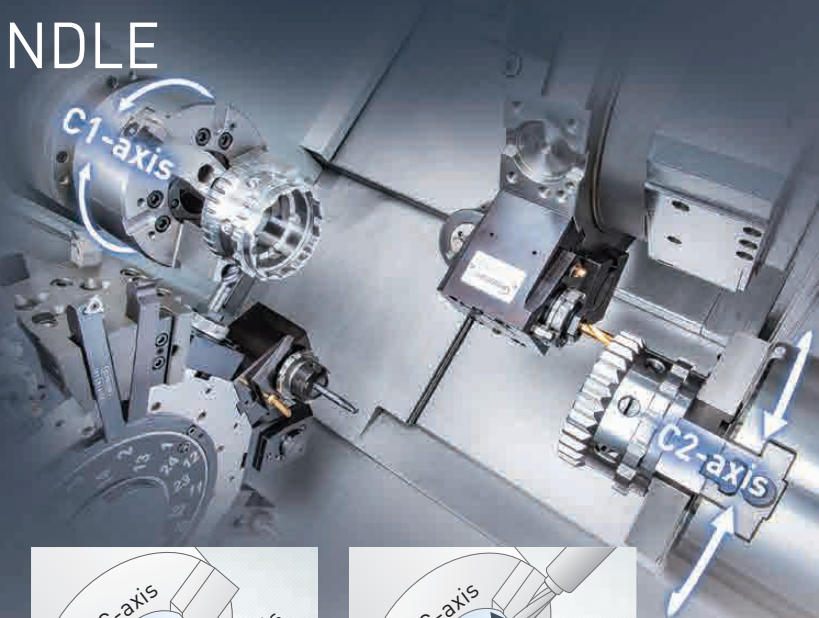

## CUTTING EXAMPLE

Chip removal rate **176** cm<sup>3</sup>/min.

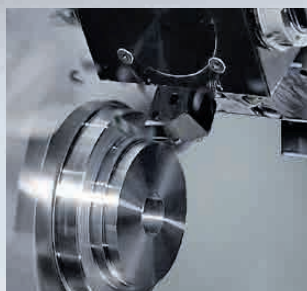

### The upper turret turning on the spindle 1

Depth of Cut (AP) : 4 mm  
Speed (V) : 200 mm/min.  
Feed Rate (F) : 0.22 mm/rev  
Material : S45C

Spindle load  
104%

### The upper turret turning on the spindle 2

Depth of Cut (AP) : 4 mm  
Speed (V) : 200 mm/min.  
Feed Rate (F) : 0.22 mm/rev  
Material : S45C

Spindle load  
107%



### The lower turret turning on the spindle 1

Depth of Cut (AP) : 4 mm  
Speed (V) : 200 mm/min.  
Feed Rate (F) : 0.22 mm/rev  
Material : S45C

Spindle load  
106%

### The lower turret turning on the spindle 2

Depth of Cut (AP) : 4 mm  
Speed (V) : 200 mm/min.  
Feed Rate (F) : 0.22 mm/rev  
Material : S45C

Spindle load  
110%

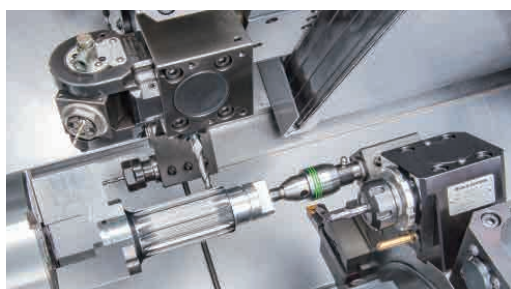

### More Flexible Processing Applications

More flexibility for processing is allowed as the lower turret is available for installation of various types of fixtures such as center, steady rests and work support other than turrets.

# TWIN Y AXES CONTROL FUNCTION

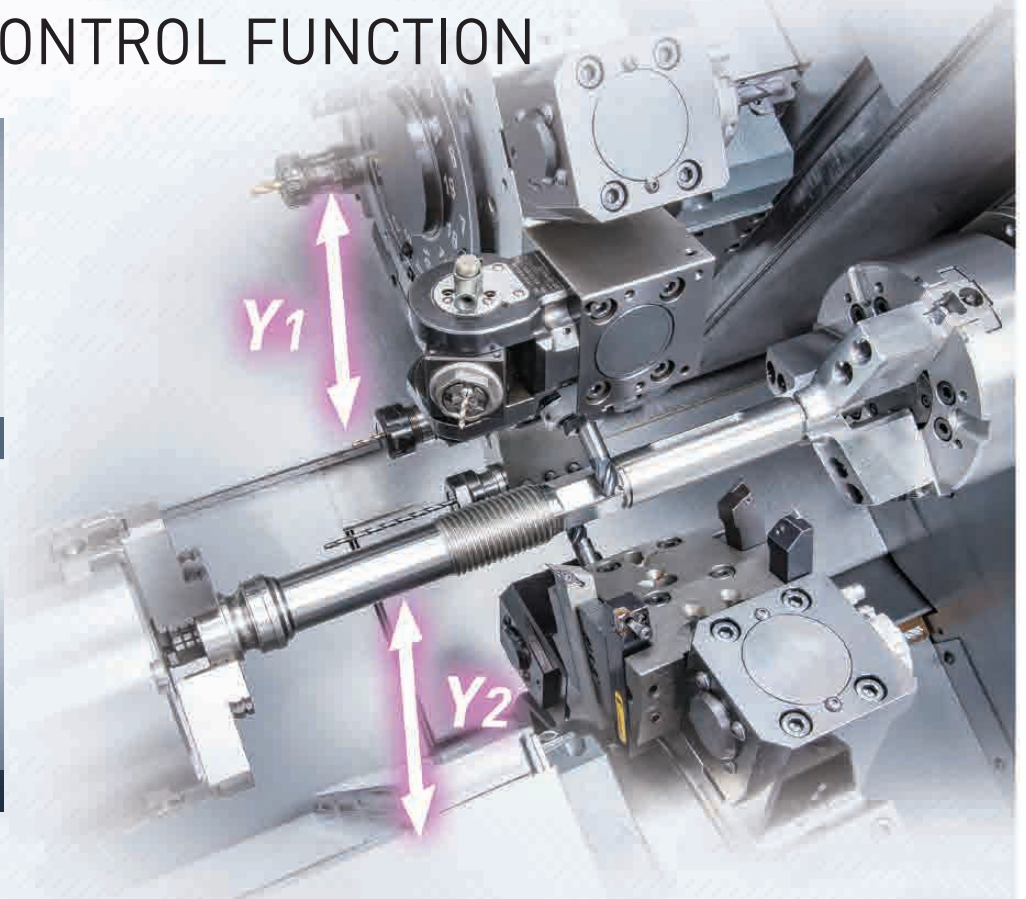
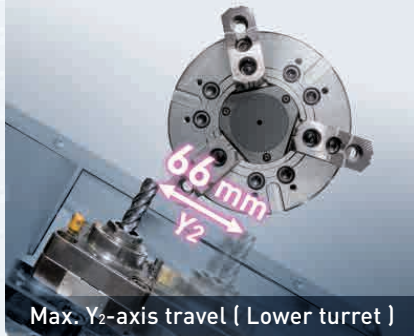
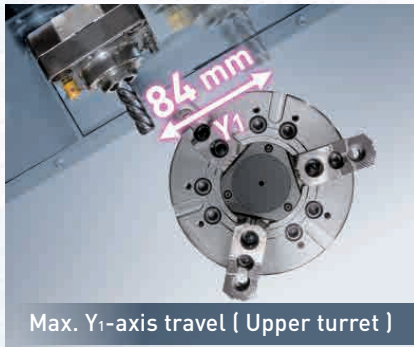

Y-axis control function can achieve simultaneous X, Y, Z and C axes machining, which is capable of working on Y-axis off center milling, drilling and tapping while improving the machining accuracy for multiple parts processing, such as high precision grooving and X-axis off center drilling.

The upper and lower turrets that are equipped with Y-axis control not only allow the GTZ-1500 series to mill extremely complex parts, but also make the process arrangement more flexible than the conventional dual-Y-axis models, thereby achieving higher processing efficiency.

## High Precision Y-axis Machining Capability

— Polar coordinate interpolation **V.S** Y-axis control —

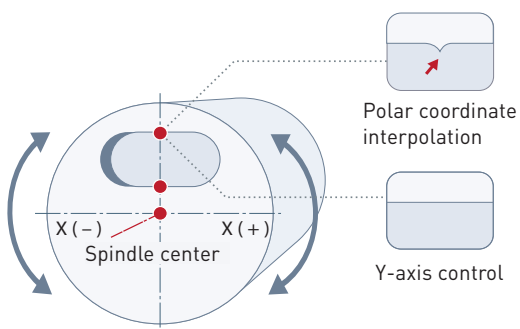

The polar coordinate interpolation can work on troughing or contouring. X-axis reverses at cross point of the center point of workpiece and contour, which makes tool not able to be completely contouring and remains worse accuracy.

With Y-axis control, it can avoid the situation above and remain better accuracy.

O.D. Troughing

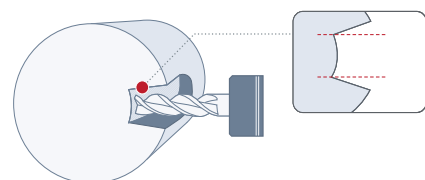

Without featuring Y-axis, width of troughs are not perfectly parallel with worse accuracy.

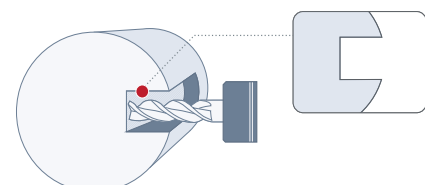

Featuring Y-axis, width of trough remains parallel with better accuracy.

# OPTIONAL ADVANCED CONTROL FUNCTIONS

## INTELLIGENT OPERATING SYSTEM **G.LINC**

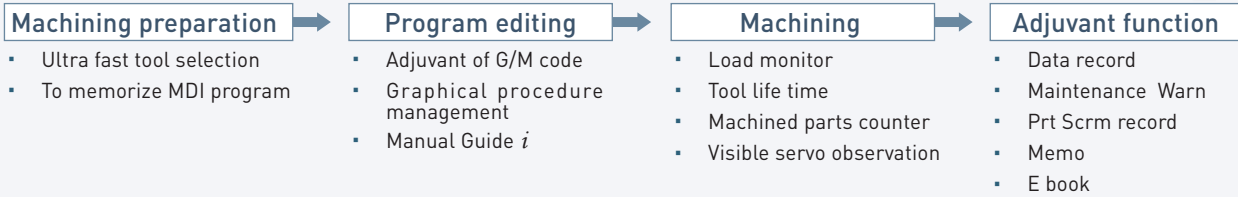
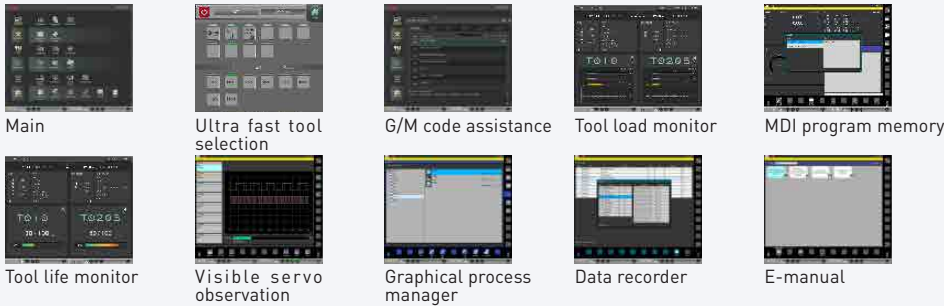

## OSCILLATING CHIP REMOVAL ( OCR )

OCR oscillating cutting function is to air cut fine chips while oscillates the slide axis fully synchronized relative to spindle rotation. No mechanical failure occurred due to entangled chips which enhances machine effectiveness.

### General Turning

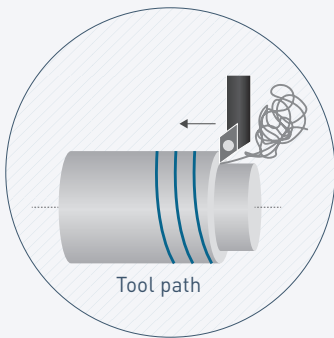

### Oscillating Turning

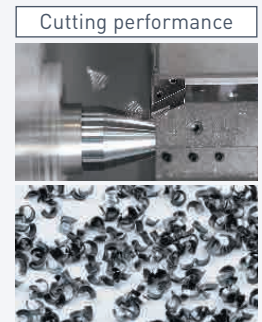
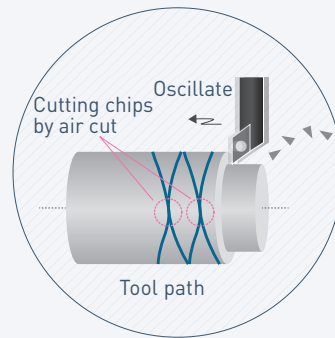

## SMART CHUCK SENSOR

When changing different size of parts, only do simple setting on controller then can adjust checking position. Not only ensure the main spindle, chuck clamping / unclamping function but also without complicated procedure by traditional manual method.

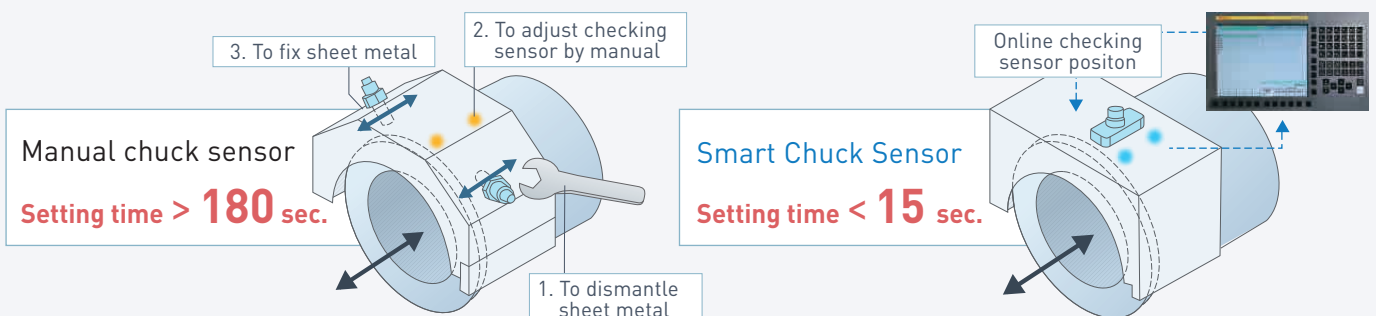

Setting time depends on difference range setting value.

## AIR BAG

The load of servo motor can be detected in real time. When the load is at an abnormally large value ( such as in case of machine collision ), the system immediately shifts to emergency stop mode and retract servo axes in the meantime. Such immediate risk control mechanism can save the cost of machine repair and diminish production loss due to machine down.

Retract tools within **0.009 sec.**

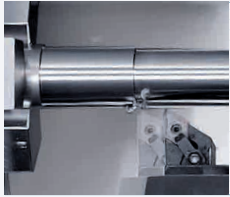

### Equipped with Air Bag

- Machine crash ▶ EMG mode
- ▶ Servo motor reverse rotary
- ▶ Machine stop

- Short maintenance time · Less mechanical damage
- Overload predictable

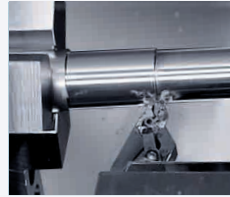

### Not equipped with Air Bag

If axes continue feeding after machine collision, the overall mechanical structure and work pieces will be severely damaged.

- Long maintenance time · Severe mechanical damage
- Overload unpredictable

## SERVICE CUBE

Via service cube, no matter where you are in the world ( as long as internet available ), you can do machine setting, monitoring, maintenance, upload / download program, etc.. Machine maintenance efficiency can be increased, manpower and traffic cost can be decreased.



### Machine with Service Cube

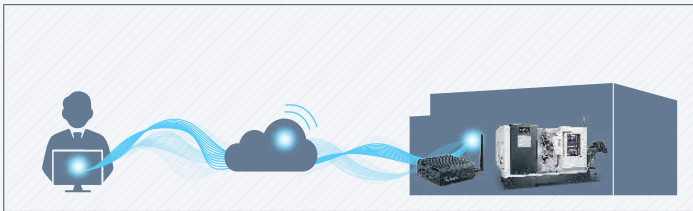

### Machine without Service Cube

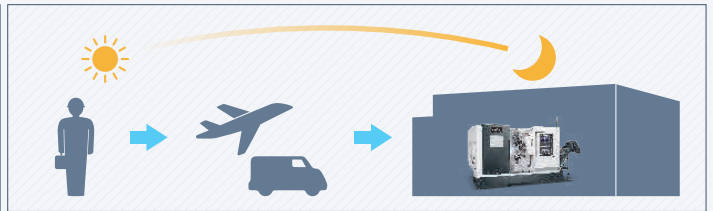

## LOAD MONITOR

Load monitoring function can be check the abnormal tool load via detecting the electric current variation of spindle and servo motor when turning. When abnormal loading occur, if achieve tool life, machine will stop when program end ( M30 ); If achieve wear value, machine will immediately pause the feedrate but spindle not stop.

### Tool Monitoring

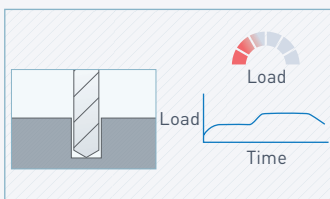

Tool life achievement

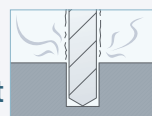

Machine stop

Tool wear

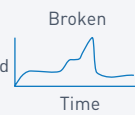
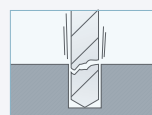

Feedrate stop

# EQUIPMENT THAT INCREASES PRODUCTIVITY

## Gantry Loader

Equipped with gantry loader, the GTZ series can save manpower demand and achieve fully automated production.

※ Please contact with GOODWAY for customized automatically system.



**Twin Jaws Robot Arm**



**Auto Door**

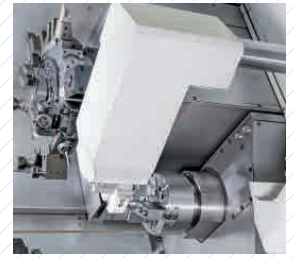

**Robot-type Parts Catcher**

Max. part diameter : Ø 65 mm  
Max. part length : 150 mm  
Max. part weight : 3 kg



**Parts Conveyor**

Conveyor integrated inside the mechanism, which is equally safe and aesthetic.

※ customized unloading system is available.

## Bar Feeder



Bar diameters : Ø 5 ~ 65 mm ( 0.19" ~ 2.55" )  
Bar storage capacity : Ø 65 mm ( 2.55" ) × 10 bars

The limitation of bar length is based on the sum length of spindle and workpiece ( summed length of workpiece, chuck, spindle, cylinder and the length of spindle rear cover ). If the extension length of the bar exceeds the rear cover of spindle, a supplement of bar support device is necessary. Otherwise, the bar may be bent during machining process and consequently cause personnel injuries.

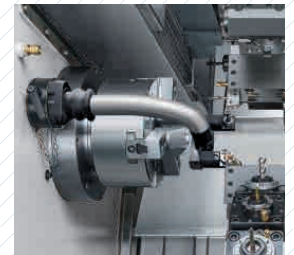

**Tool Presetter**

Auto simultaneous measurement of twin turrets and removable probe arm.

## High Pressure Coolant System



Max. Pressure : 70 bar  
Max. Flow Rate : 30 LPM  
Coolant Type : Water or Oil

- Pressure output monitoring system
- Filter replacement checking
- Super large capacity coolant tank
- Patented diaphragm pump ( made in USA. )
- Touch screen of HMI
- Intelligent automatic pressure control

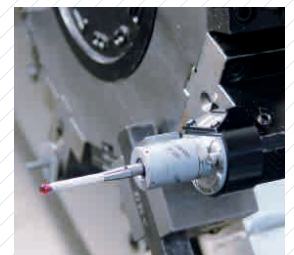

**Workpiece Inspection Probe**

Available for the identification and set up of workpieces, real-time monitor the surface of workpiece and verification the dimension of finished part.



# STANDARD & OPTIONAL FEATURES

S : Standard      O : Option  
 - : Not Available    C : Contact GOODWAY

SPINDLE 1 & SPINDLE 2		
Main spindle motor configuration	Belt driven	S
Rigid tapping & spindle orientation		S
Spindle disk brake		S
C-axis & spindle disk brake		S
WORK HOLDING		
Hydraulic hollow cylinder for chuck		S
Hydraulic hollow 3-jaw chuck	6"	S
Hard jaws		O
Collet chuck		O
Special work holding chuck		C
In spindle work stopper		O
Spindle liner ( guide bushing )		O
Foot switch for chuck operation		S
UPPER & LOWER TURRETS		
Turret	12-station	S
Live tooling turret	12-station	O
	24-station	O
Tool holder & sleeve package		S
Live tooling tool holders ( 0° × 2, 90° × 2 ) <sup>*1</sup>		O
MEASUREMENT		
RENISHAW HPRA tool presetter	Removeable	O
COOLANT		
Coolant pump	5 kg/cm <sup>2</sup> ( 60HZ )	S
	15 kg/cm <sup>2</sup> ( 60HZ )	O
High-pressure coolant system	70 kg/cm <sup>2</sup>	C
Roll-out coolant tank		S
Oil skimmer		O
Coolant flow switch		O
Coolant level switch		O
Coolant intercooler system		O
CHIP DISPOSAL		
Chip conveyor	Right discharge	S
	Rear discharge	C
Chip cart with coolant drain		S
Chuck air blow		O
Coolant gun		O
Oil mist collector		O
AUTOMATIC OPERATION SUPPORT		
Parts catcher		S
Work-piece transport conveyor		S
Bar feeder		O
Bar feeder interface		O
Gantry-type loader / unloader		O
Auto door		O
Extra M-code output	4 sets ( 8 )	O
	8 sets ( 16 )	O
SAFETY		
Fully enclosed guarding		S
Door interlock ( incl. mechanical lock )		S
Impact resistant viewing window		S
Chuck cylinder stroke out-end check		S
Chuck cylinder check valve		S
Low hydraulic pressure detection switch		S
Over travel ( soft limit )		S
Load monitoring function		O

\*1 Available for live tooling turret or Y-axis model.

OTHERS		
Tri-color operation status light tower		S
Florescent work light		S
External work light		O
Electrical cabinet	Heat exchanger	S
	A/C cooling system	O
Complete hydraulic system		S
Advanced auto lubrication system		S
Emergency maintenance electrical part package		S
Operation & maintenance manuals		S

FANUC CONTROL FUNCTIONS		
Display	15" color LCD	S
Graphic function	Standard	S
	Dynamic	O
	256 K	S
	512 K	O
Part program storage size ( total )	1M bytes	O
	2M bytes	O
	4M bytes	O
	8M bytes	O
Registerable programs ( total )	1,000	S
	4,000	O
	200	S
	400	O
Tool offset pairs ( total )	499	O
	999	O
	2000	O
	HRV 3	S
Servo HRV control	HRV 3	S
Automatic data backup		S
Synchronous / Composite control		O
Inch / metric conversion		S
Polar coordinate interpolation		S
Cylindrical interpolation		S
Multiple repetitive cycle		S
Rigid tapping		S
Unexpected disturbance torque detection function		S
Spindle orientation		S
Spindle speed fluctuation detection		S
Embedded macro		O
Spindle synchronous control		S
Run hour and parts count display		S
Tool radius / Tool nose radius compensation		S
Polygon turning		O
Helical interpolation		O
Direct drawing dimension programming		S
Thread cutting retract		S
Variable lead threading		S
Multiple repetitive cycle II		S
Canned cycles for drilling		S
Tool nose radius compensation		S
Chamfering / Corner R		S
AI contour control I		S
Multi part program editing		O
Manual handle retrace		O
Manual intervention and return		O
External data input		S
Addition of custom macro		S
Increment system C		S
Run hour & parts counter		S
Auto power-off function		S
RS-232 port		S
Memory card input / output ( CF + USB )		S
Ethernet		S

Specifications are subject to change without notice.

12-station live tooling turret Interference Diagram

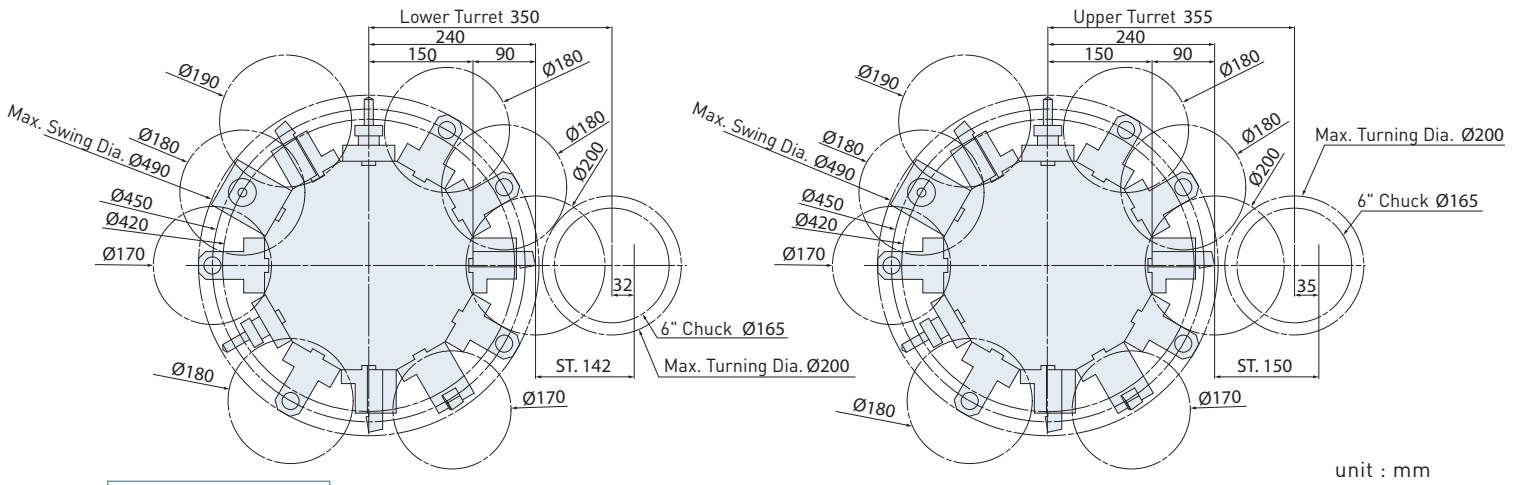

unit : mm

Tooling System

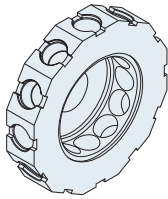

O.D. Tool Holder			
DG-3671		CF-3048	
O.D. Tool Holder			
DG-3672		CF-3048	
Cut-off Tool Holder			
DG-3673			
Cut-off Tool Holder			
DG-3674			
Face Tool Holder			
DG-3675		CF-3048	
Dual-face O.D. Tool Holder			
DG-3676		CF-3048	
I.D. Tool Holder			 
DG-3677		DG-3683	CF-3048
0° Live Tool Holder			
DG-3685			
90° Live Tool Holder			
DG-3686			

# 24-station live tooling turret Interference Diagram

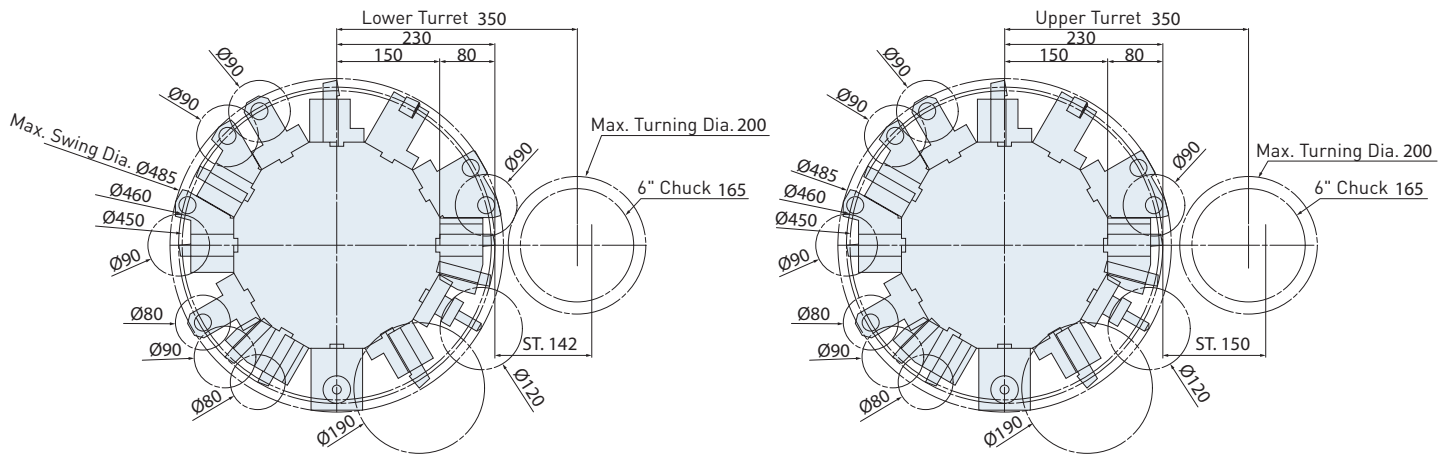

unit : mm

## Tooling System

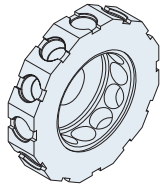

O.D. Tool Holder DG-3671			
O.D. Tool Holder DG-3672			
Cut-off Tool Holder DG-3673			
Cut-off Tool Holder DG-3674			
Face Tool Holder DG-3675			
Dual-face O.D. Tool Holder DG-3676			
I.D. Tool Holder DG-3677		 	
Double I.D. Tool Holder DG-3678		 	
Double O.D. Tool Holder DG-3679		   	
Dual-face O.D. Tool Holder DG-3680		  	
0° Live Tool Holder DG-3685			
90° Live Tool Holder DG-3686			



# SPECIFICATIONS

■ : Metric ■ : Inch

## GTZ-1500

### CAPACITY

Max. swing diameter	Ø 200 mm 7.87"		
Max. turning diameter	Ø 180 mm 7.08"	Ø 200 mm 7.87"	
Max. turning length	590 mm 23.22"		
Max. loading weight	15 kg 33 lb		
Hydraulic chuck	6"		
Bar capacity	Ø 45 mm 1.77"	Ø 51 mm 2"	Ø 65 mm 2.55"
Spindle nose distance	Max. 820 / Min. 195 mm 32.28" / 7.67"		
Spindle center height	1,200 mm 47.24"		

### SPINDLE 1

Hole through draw tube	Ø 46 mm 1.81"	Ø 52 mm 2.04"	Ø 66 mm 2.59"
Draw tube OD.	Ø 55 mm 2.16"	Ø 62 mm 2.44"	Ø 76 mm 2.99"
Hole through spindle	Ø 56 mm 2.2"	Ø 63 mm 2.48"	Ø 78 mm 3.07"
Front spindle bearing diameter	Ø 80 mm 3.14"	Ø 90 mm 3.54"	Ø 110 mm 4.33"
Rear spindle bearing diameter	Ø 70 mm 2.75"	Ø 80 mm 3.14"	Ø 100 mm 3.93"
Hydraulic cylinder	6"		
Spindle nose	A2-5	A2-5	A2-6
Motor output ( Cont. )	7.5 kW 10 HP	7.5 kW ( Opt. 11 kW ) 10 HP ( Opt. 15 HP )	
Motor output ( 15 min. )	11 kW 15 HP	11 kW ( Opt. 15 kW ) 15 HP ( Opt. 20 HP )	
Motor full output speed	1,500 rpm	1,500 rpm	
Spindle drive system	Direct belt drive		
Spindle drive ratio	1.08	1.11	1.21
Spindle speed range	6,000 rpm	5,000 rpm	4,500 rpm
Spindle full output speed	1,852 rpm	1,802 rpm ( Opt. 1,351 rpm )	1,653 rpm ( Opt. 1,240 rpm )
Spindle torque ( Cont. )	39 Nm 28 lb-ft	40 Nm ( Opt. 78 Nm ) 29 lb-ft ( Opt. 57 lb-ft )	43 Nm ( Opt. 85 Nm ) 31 lb-ft ( Opt. 62 lb-ft )
Spindle torque ( 15 min. )	76 Nm 56 lb-ft	78 Nm ( Opt. 130 Nm ) 57 lb-ft ( Opt. 95 lb-ft )	85 Nm ( Opt. 143 Nm ) 62 lb-ft ( Opt. 105 lb-ft )

### SPINDLE 2

Hole through draw tube	Ø 46 mm 1.81"	Ø 52 mm 2.04"	Ø 66 mm 2.59"
Draw tube OD.	Ø 55 mm 2.16"	Ø 62 mm 2.44"	Ø 76 mm 2.99"
Hole through spindle	Ø 56 mm 2.2"	Ø 63 mm 2.48"	Ø 78 mm 3.07"
Front spindle bearing diameter	Ø 80 mm 3.14"	Ø 90 mm 3.54"	Ø 110 mm 4.33"
Rear spindle bearing diameter	Ø 70 mm 2.75"	Ø 80 mm 3.14"	Ø 100 mm 3.93"
Hydraulic cylinder	6"		
Spindle nose	A2-5	A2-5	A2-6
Motor output ( Cont. )	7.5 kW 10 HP	7.5 kW ( Opt. 11 kW ) 10 HP ( Opt. 15 HP )	
Motor output ( 15 min. )	11 kW 15 HP	11 kW ( Opt. 15 kW ) 15 HP ( Opt. 20 HP )	
Motor full output speed	1,500 rpm	1,500 rpm	
Spindle drive system	Direct belt drive		
Spindle drive ratio	1.08	1.11	1.21
Spindle speed range	6,000 rpm	5,000 rpm	4,500 rpm
Spindle full output speed	1,852 rpm	1,802 rpm ( Opt. 1,818 rpm )	1,653 rpm ( Opt. 1,240 rpm )
Spindle torque ( Cont. )	39 Nm 28 lb-ft	40 Nm ( Opt. 58 Nm ) 29 lb-ft ( Opt. 42 lb-ft )	43 Nm ( Opt. 64 Nm ) 31 lb-ft ( Opt. 47 lb-ft )
Spindle torque ( 15 min. )	76 Nm 56 lb-ft	78 Nm ( Opt. 105 Nm ) 57 lb-ft ( Opt. 77 lb-ft )	85 Nm ( Opt. 116 Nm ) 62 lb-ft ( Opt. 85 lb-ft )

## GTZ-1500

C-AXIS			
Drive type	Cs		
C-axis torque	39 Nm 28 lb-ft	40 Nm 29 lb-ft	43 Nm 31 lb-ft
Positioning accuracy	63 arc-sec 0.0175°		
Repeatability	25 arc-sec 0.0069°		
X / Z AXES			
Max. X <sub>1</sub> / X <sub>2</sub> axes travel	150 / 137 mm 5.9" / 5.39"	150 / 142 mm 5.9" / 5.59"	
Max. Z <sub>1</sub> / Z <sub>2</sub> / Z <sub>s</sub> axes travel	590 / 561 / 625 mm 23.22" / 22.08" / 24.6"		
X / Z axes rapid	20 / 40 m/min. 787 / 1,574 IPM		
Z <sub>s</sub> -axis rapid	40 m/min. 1,574 IPM		
Slide way type	Linear Guide Way		
Feed rates	1 ~ 4,800 mm/min. 1 ~ 189 IPM		
X <sub>1</sub> / X <sub>2</sub> axes servo motor	2.5 / 1.8 kW 3.3 / 2.4 HP		
Z <sub>1</sub> / Z <sub>2</sub> / Z <sub>s</sub> axes servo motor	1.8 / 1.8 / 1.8 kW 2.4 / 2.4 / 2.4 HP		
Y-AXIS			
Max. Y <sub>1</sub> -axis travel	± 42 mm ± 1.65"		
Max. Y <sub>2</sub> -axis travel	± 33 mm ± 1.29"		
Y <sub>1</sub> / Y <sub>2</sub> axes rapids	8 m/min. 314 IPM		
Slide way type	High Rigidity Box Way		
Feed rates	1 ~ 4,800 mm/min. 1 ~ 189 IPM		
Y-axis servo motor	1.2 kW 1.6 HP		
UPPER & LOWER TURRETS			
Stations ( Upper + Lower )	12 + 12 ( Opt. 24 + 24 )		
Live tooling stations ( Upper + Lower )	12 + 12		
Indexing drive	FANUC AC Servo motor		
Indexing speed	0.2 sec. Adjacent / 0.7 sec. 180° degree ( Single step )		
O.D. tool shank size	□ 20 mm ( 12T ) / □ 16 mm ( 24T ) 3/4" / 5/8"		
I.D. tool shank size	∅ 25 mm 1"		
Live tooling drive motor	2.2 kW ( Opt. 2.2 / 5.5 kW ) 3 HP ( Opt. 3 / 7.4 HP )		
Live tooling shank size	ER20 ( ∅ 13 mm ) 0.51"		
Live tooling RPM range	6,000 rpm ( Opt. 8,000 rpm )		
CLAW-TYPE PART CATCHER ( Opt. )			
Max. work-piece diameter	∅ 65 mm 2.55"		
Max. work-piece length	150 mm 5.9"		
Max. work-piece weight	3 kg 6.6 lb		

## GTZ-1500

### GENERAL

Positioning accuracy	0.01 mm 0.0003"
Repeatability	± 0.003 mm ± 0.0001"
NC controller	FANUC 31i
Voltage / Power requirement	AC 200 / 220 + 10 % to - 15 % 3 Phase / 60 kVA
Hydraulic tank capacity	35 L × 2 9.2 gal × 2
Coolant tank capacity	450 L 118 gal
Coolant pump / pressure	0.78 kW ( 1 HP , 60 Hz ) rated at 5 bar ( 72.5 PSI )
Machine weight	9,000 kg 19,800 lb
Machine weight ( GTZ-1500Y )	9,500 kg 21,000 lb
Dimensions ( L × W × H )	3,120 × 2,065 × 2,130 mm 123" × 82" × 84"

Specifications are subject to change without notice.

### Machine Layout

#### GTZ-1500Y

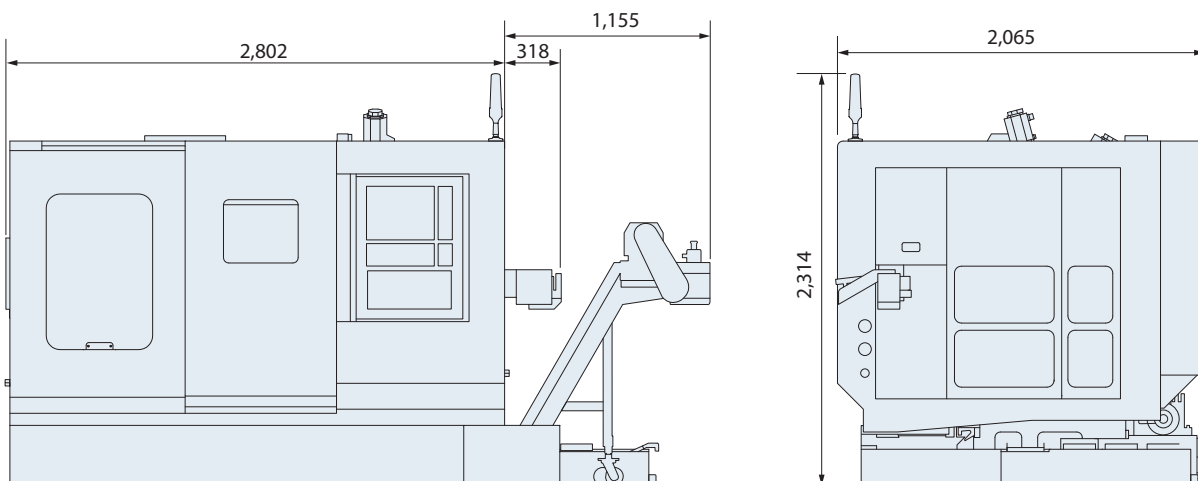

Unit: mm

## GTZ-2600 SERIES

■ : Metric ■ : Inch

### High Productivity Multi-Axis Turning Centers

- Bar capacity :  $\varnothing$  65 mm 2.55"
- Max. turning length : 500 / 600\*1 mm  
19.68" / 23.62"
- Chuck size : 8" ( Big-Bore )
- 12 / 16 / 24 stations turret
- Optional Y-axis ( Upper Turret )



\*1 For 16-station turret

( GTZ-2600Y model shown with optional G.LINC intelligent control system. )



GOODWAYCNC.com

## GOODWAY MACHINE CORP.

### HEADQUARTERS

No.13, 5<sup>th</sup> Road,  
Taichung Industrial Park,  
Taichung City, 407, Taiwan  
E-mail : [goodway@goodwaycnc.com](mailto:goodway@goodwaycnc.com)

### CENTRAL TAIWAN SCIENCE PARK BRANCH

No. 38, Keyuan Road,  
Central Taiwan Science Park.Taichung,  
Taichung City, 407, Taiwan  
TEL : + 886-4-2463-6000  
FAX : + 886-4-2463-9600

### GOODWAY MACHINE ( WUJIANG ) CO.,LTD

No. 4888, East Lake Taihu Avenue, Wujiang  
Economic and Technological Development Zone,  
Jiangsu, China  
Sales Hot line : + 86-512-8286-8680  
Service Hotline : + 86-512-8286-8066  
FAX : + 86-512-8286-8620  
E-mail : [goodway@goodwaycnc.cn](mailto:goodway@goodwaycnc.cn)